



spier®

FAHRZEUGWERK



ATV_V1.4_250501_ENGLISH





Table of Contents

1	About these operating instructions	41
1.1	Relevant document	41
1.2	Symbols and notices	41
2	Product information	42
2.1	Product name and type designation	42
2.2	Manufacturer information	42
2.3	Service information	42
3	Safety	43
3.1	Intended use	43
3.2	Duties of the operator (end user)	44
3.3	Operating components safely	45
3.4	Personal protective equipment	45
3.5	Warning and information signs	45
3.6	Using the ATV product portfolio safely in all stages of life	46
3.6.1	Transport, installation, commissioning	46
3.6.2	Operation	46
3.6.3	Maintenance	46
3.6.4	Service	47
3.6.5	Removal, disposal	47
4	Shelving system	48
4.1	Product description	48
4.2	Figure	48
4.3	Warning and information signs	49
4.4	Safety	50
4.5	Operation	50
5	Fire extinguisher	51
5.1	Product description	51
5.2	Figure	51
5.3	Operation	51
6	Handle – right back door	52
6.1	Product description	52
6.2	Figure	52
6.3	Operation	52
7	Hand truck mount	53
7.1	Product description	53
7.2	Figure	53
7.3	Operation	54
8	Stop counter	55
8.1	Product description	55
8.2	Figure	55
8.3	Operation	55
9	Fittings – interior customs seal	56
9.1	Product description	56
9.2	Figure	56
9.3	Operation	56





10 Locking system on partition wall sliding door.....	57
10.1 Product description.....	57
10.2 Figure	57
10.3 Operation.....	58
11 Hand truck	59
11.1 Product description.....	59
11.2 Figure	59
11.3 Operation.....	59
12 Locking system on cargo doors – TVG brand	60
12.1 Product description.....	60
12.2 Figure	60
12.3 Operation.....	61
12.3.1 ARTICLE CANCELLED	61
12.3.2 Sliding side cargo door.....	62
12.3.3 Back door	62
13 Locking system on cargo doors – ATV brand	63
13.1 Product description.....	63
13.2 Figure	63
13.3 Operation.....	63
13.3.1 Partition wall sliding door	64
13.3.2 Sliding side cargo door.....	64
13.3.3 Back door	65
14 DPS holder – fixed partition wall.....	66
14.1 Product description.....	66
14.2 ARTICLE CANCELLED	66
14.3 Operation.....	66
15 DPS holder – partition wall with sliding door.....	67
15.1 Product description.....	67
15.2 ARTICLE CANCELLED	67
15.3 Operation.....	67
16 Key tags.....	68
16.1 Product description.....	68
16.2 Figure	68
16.3 Operation.....	68
17 High-visibility vests	69
17.1 Product description.....	69
17.2 Figure	69
17.3 Operation.....	69
18 Telematics	70
18.1 Product description.....	70
18.2 Figure	70
18.3 Operation.....	70
19 Scanner / monitor mount.....	71
19.1 Product description.....	71
19.2 Figure	71
19.3 Operation.....	71



20 Document pouch	72
20.1 Product description	72
20.2 Figure	72
20.3 Operation	72
21 Fittings – exterior customs seal	73
21.1 Product description	73
21.2 Figure	73
21.3 Operation	73
22 Fittings – for exterior padlock	74
22.1 Product description	74
22.2 Figure	74
22.3 Operation	74
23 Padlock	75
23.1 Product description	75
23.2 Figure	75
23.3 Operation	75
24 Rear step.....	76
24.1 Product description	76
24.2 Figure	76
24.3 Operation	76
25 Partition wall with sliding door.....	77
25.1 Product description	77
25.2 Figure	77
25.3 Warning and information sign	77
25.4 Operation	78
26 Storage compartment for charging cable bag	79
26.1 Product description	79
26.2 Figure	79
26.3 Warning and information sign.....	79
26.4 Operation	79

Change history

Version	Date	Change
1.0	July 2021	Initial version
1.1	July 2021	General revision
1.2	July 2022	25.2 Adjust sliding door
1.3	November 2023	10+13 Adjust sliding door
1.4	May 2025	5 Fire extinguisher, 12 Locking system on cargo doors, 14/15 DPS holder, 19 Scanner-/ monitorholder, 20 Document bag, 24 Rear step / Side step, 26 Storage compartment for charger cable bag



1 About these operating instructions

This documentation is intended for two types of users:

- Business and technical entities instances requiring operating instructions for the components from the ATV product portfolio they built in or distributed (B2B users)
- Operator staff (end users)

Within the context of these instructions, operating personnel means the group of persons assigned with the operation, maintenance including cleaning and troubleshooting.

- The components in the ATV product portfolio may only be operated or maintained by trained and authorised persons.
- The responsibility for the various tasks must be clearly defined and observed. There must be no unclear components with respect to safety aspects.
- Any person that is part of the operator's operating personnel must read and understand the "Safety" chapter and the safety instructions for the respective components.

1.1 Relevant document

These instructions are a so-called relevant document. The instructions must be included by the distributor or the installer of the vehicle body resp. used for the operating instructions it writes.

In addition, all included operating instructions of the original manufacturers apply, particularly for products requiring explanation beyond the scope of these instructions.

1.2 Symbols and notices

The following notices warn the user of personal injury and property damage.



CAUTION

This symbol indicates a potentially hazardous situation.
Failure to observe this notice can result in injuries or property damage.



NOTE

This symbol indicates important notices related to proper use of the components from the ATV product portfolio.
Failure to observe this notice can result in property damage.





2 Product information

2.1 Product name and type designation

Product name:	ATV product portfolio
Year of manufacture (see Spier type plate in the base vehicle)	05/2025 ->

2.2 Manufacturer information

Name:	Spier GmbH & Co. Fahrzeugwerk KG
Address:	Schorlemerstraße 1, 32839 Steinheim, Germany
Email:	info@spier.de
Phone:	+49 5233 945-0
Website:	www.spier.de

2.3 Service information

Name:	ATV GmbH & Co. KG
Address:	Heinrich-Spier-Straße 24, 32839 Steinheim, Germany
Email:	info@atv-fahrzeugtechnik.de
Phone:	+49 5233 945-2391
Website:	www.atv-fahrzeugtechnik.de





3 Safety

3.1 Intended use

Purpose

ATV products are a system for special vehicle fixtures to safely transport packages and other goods which can be stacked on shelves. They are installed in standard delivery vans. Use in the respective desired vehicle model must be coordinated with Spier, as the installation dimensions of some components vary.

The limits of the components in the ATV product portfolio are determined by their dimensions and the corresponding information and warning signs.

Foreseeable misuse

Avoid the following misuses:

- installing the components in vehicle models which are not approved
- unauthorised modification or conversion of the components and their protective devices which does not meet the relevant regulations
- bypassing or disabling safety and protective devices
- transported non-approved materials and dangerous goods
- using unsuitable tools (e.g. unsuitable hoists) with the ATV product portfolio

We assume no warranty for compatibility when combining components from the ATV product portfolio with external components not supplied by Spier.

Operator rights and duties

Only the actions specified in these operating instructions are permitted. In addition, the operator must ensure:

- Observe all notices in the operating instructions and relevant documents.
- Carry out all maintenance per the service schedule.

Spier customer service

Only Spier customer service or technical staff qualified for the respective task may carry out work not specified in these instructions.



3.2 Operator obligations (end user)

Qualify personnel and appoint according to qualification

The operator must ensure:

- The personnel is familiar and instructed on the basic rules of industrial safety and accident prevention.
- Only qualified and instructed personnel may work on the components from the ATV product portfolio.
- The responsibilities for work during the life cycles of the components are assigned to staff per the following table:

Qualification level	Description	Duties permitted in life stages
Instructed persons	An instructed person is on instructed and if necessary trained in the assigned tasks and potential dangerous due to improper conduct and instructed on the necessary safety devices and safeguards.	Operation
Technical staff	Technical staff has the professional training, knowledge and experience and is familiar with the relevant regulations to assess the assigned tasks and recognise potential dangers. Comment: Qualification equivalent to professional education can also be gained from years of experience working in the respective field.	Transport commissioning operation maintenance Decommissioning / disposal

Detecting unknown risks

The operator is obligated to cooperate in detecting unknown risks. The operator must particularly:

- Take the necessary measures to ensure industrial safety based on the Occupational Safety and Health Act, the Ordinance on Industrial Safety and Health or national regulations.
- Report unknown dangers not indicated in these operating instructions to the manufacturer.
- Report accidents and near misses to the manufacturer.



3.3 Proper component operation

Ensure in all life stages of components from the ATV product portfolio:

- Only operate the components as intended, in proper technical condition and taking into account safety and dangers!
- Observe the operating data.
- Do not use the components in the following cases:
 - safety device fault or failure
 - other incorrect function or abnormal functional behaviour
- do not remove or bypass safety devices and switching signals.
- When lifting heavy loads manually, do not exceed the respective guidelines.

3.4 Personal protective equipment

The operating personnel is obligated to wear the following protective equipment when performing maintenance.

Pictogram	Description
	<p>Foot protection must be worn</p> <p>Foot protection protects the feet from being crushed, falling parts and slipping on slippery surfaces.</p>
	<p>Wear protective gloves</p> <p>Protective gloves protect the hands from being crushed, abrasions, punctures or deep injuries.</p>

3.5 Warning and information signs

Individual components from the ATV product portfolio bear labels containing additional information and alerting to dangers. The labels must be legible throughout the life of the base vehicle and replaced immediately if damaged.



CAUTION

Danger due to missing or illegible signs.

- ♦ Observe signs!
- ♦ Warning signs must be clearly visible and Otherwise they must be replaced.
- ♦ Do not carry out work and contact the manufacturer if you are unclear or have questions.

3.6 Safe use of the ATV product portfolio in all life stages

This chapter contains information about safe handling of the components from the ATV product portfolio over the life stages of the system.

3.6.1 Transport, installation, commissioning

Where possible, transport, installation and commissioning is carried out by Spier. If the operator is required to carry out the corresponding work in exceptional cases, ensure:

- Hoists and lifting accessories must be used by trained personnel.
- Use hoists and lifting accessories with adequate capacity (e.g. forklift).
- Note the centre of gravity, weight specification and transport speed for hoisting.
- Wear personal protective equipment (gloves, foot protection, helmet).
- Electrical work must be carried out by an electrician. Observe the five safety rules for working with electrical equipment
- Use state of the art workshop equipment including the required speciality tools or installation devices.

3.6.2 Operation

See chapter 4 bis 25.

3.6.3 Maintenance

The scope and frequency of inspections and maintenance is primarily based on the operating conditions.

Electrical maintenance must be carried out by an electrician.

Improper care and cleaning can affect the function of ATV product portfolio components.

- Do not clean with dry, rough or hard cloths.
- Never clean with scouring cream, solvents or cleaners containing solvents.
- Plastic parts can be wiped with a damp cloth or solvent-free speciality cleaners. Paint conditions are not suitable for plastic parts.
- Cleaning dirt with aggressive cleaners containing solvents can damage the parts beyond repair, even after soaking in briefly.
- For tough or hard to access dirt, first use a soft brush. Then use a clean, soft cloth.
- Do not allow liquids to enter electrical components.

3.6.4 Service

During every vehicle services, the components from the ATV product portfolio must be checked for safety, functionality (test run) and all safety warnings being present.

For service and repairs beyond the contents of these instructions, please contact Spier customer service.

- Address see chapter 2.2

3.6.5 Decommissioning, disposal

Observe all environmental protection and waste management laws and regulations at the place the vehicle is used during decommissioning, removal and disposal.

Dispose of the materials per the following table:

Materials, substances	Classification	Task
Metals, plastics	Recyclables	reuse
Oils, greases, tin, flux, electronic parts	Hazardous waste	dispose separately
Residual waste	Waste	dispose

Disposing of electronic waste

Electronic waste often contains highly pollutant chemicals. Electronic waste therefore must not be disposed of along with regular waste.

Proper disposal of electronic waste prevents hazardous substances from harming humans and the environment. Hazardous substances are collected and valuable raw materials are recovered for reuse.

Electronic waste disposal within the European Union

European Directive 2002/96/EG on Waste Electrical and Electronical Equipment (WEEE) and the corresponding national laws govern the treatment of (waste) electrical and (waste) electronical equipment ("electronic waste") within the European Economic Area.

In some countries within the European Union (e.g. Germany), equipment distributed and used commercially (so-called B2B equipment per WEEE Directive) must also be disposed of commercially. They are not considered consumer goods and unlike electronic waste from private households (so-called B2C equipment) must not be returned to publicly funded disposal providers (e.g. local civic waste collection points) and disposed by these. Observe the regulations in your country on the on the disposal of electronic waste. When in doubt, obtain information on disposal under your local laws.



4 Shelving system

4.1 Product description

Line	Description
1	Folding shelves

4.2 Figure



Figure 1: Shelving system raised (left), down (right)



4.3 Warning and information signs

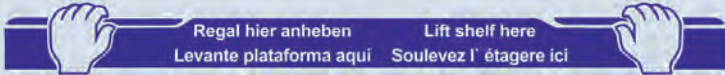
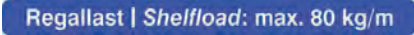

Figure 2: Shelving system detail, positions of warning signs

No.	Warning / information sign	Consequences for users
1		<p>Caution! Risk of personal injury due to crushing.</p> <ul style="list-style-type: none"> ♦ Keep hands away whilst raising and closing the door.
2		<p>Note! Lift shelf here.</p> <ul style="list-style-type: none"> ♦ Lifting to any other position may result in personal injury due to crushing. ♦ Position: centred on the shelving lifting edges
3		<p>Note! Shelving load limit per metre max. 80 kg/m.</p> <ul style="list-style-type: none"> ♦ Observe specified load limit. ♦ Secure load in place. ♦ Position: on shelving frame

4.4 Safety

Potential crushing points in the following areas.

Potential crushing points



4.5 Operation



CAUTION

Risk of personal injury due to crushing points whilst raising and lowering shelves.

- ◆ Only operate the shelves at the marked locations.



NOTE

Handle the shelving system properly.

- ◆ Do not overload! Observe the max. 80 Maximum weight capacity kg/m.

Operating shelves

1. Lift the shelf in the marked location.
2. Apply pressure to raise the shelf.
3. Ensure the shelf makes contact with the rubber on the shelving posts.
4. To lower, push down on the shelf in the marked location.

5 Fire extinguisher

5.1 Product description

Line	Description
1	Fire extinguisher at the entry area of the sliding cargo door and in the driver's cab.

5.2 Figure



Figure 3: On the load compartment partition wall / behind sliding cargo door and in the drivers cab

5.3 Operation



CAUTION

Risk of personal injury and property damage.

- Observe the warnings and instructions on the fire extinguisher.

Using the fire extinguisher

- Use the fire extinguisher per the fire extinguisher product description.

6 Handle – right back door

6.1 Product description

Line	Description
1	Inside handle, right back door

6.2 Figure

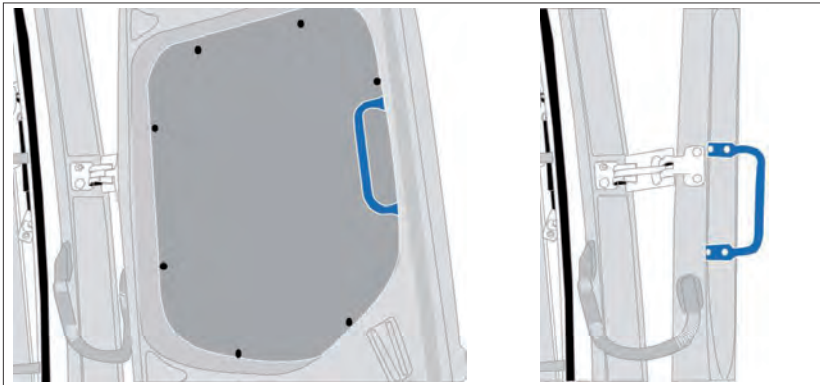

Figure 4: Handle – right back door, semi-open (left), open (right)

6.3 Operation



CAUTION

Risk of personal injury and property damage when opening the back door.

- Only use the handle to close, not to open the back door.
- Watch for objects and persons within the swing range.

Closing the back door with the handle

- Close the back door by pulling on the handle with momentum.

Do not open back door with the handle

- Do not use the handle to open the back door.



7 Hand truck mount

7.1 Product description

Line	Description
1	Hand truck mount on cargo area divider

7.2 Figure

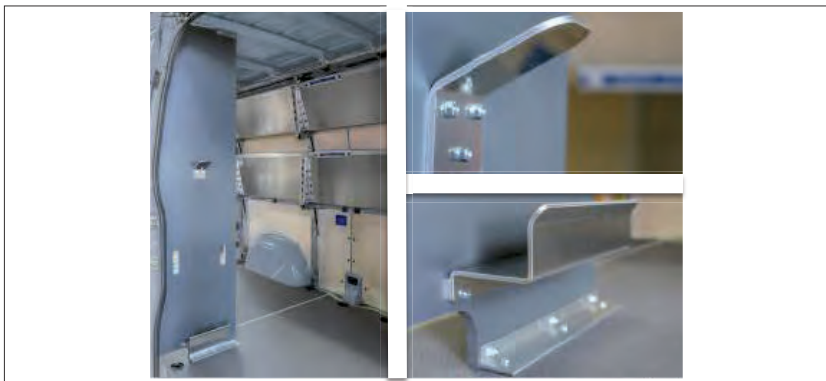

Figure 5: Hand truck mount without dolly (left), details (right)



Figure 6: Hand truck mount with dolly (left), details (right)





7.3 Operation



CAUTION

Risk of personal injury due to the hand truck falling out or being removed incorrectly.

- ♦ Lock or remove the hand truck as instructed.
- ♦ Only use model KAT7FUZ232 hand trucks (chapter 11).

Putting the hand truck away

1. Place the axle of the folded hand truck in the bottom bracket.
2. Slightly lift the hand truck and hook into the top bracket.
3. Be sure to store the hand truck in the brackets.

Removing the hand truck

1. Lift the hand truck.
2. Remove the hand cart from the mount.



8 Stop counter

8.1 Product description

Line	Description
1	Stop counter at the back left and right incl. marking

8.2 Figure



Figure 7: Stop counter

8.3 Operation



NOTE

Note the installation location.

- Inside top

Operating the stop counter

1. Push the button ①, to count up.
2. Turn the wheel ② to reset the count.



9 Fittings – interior customs seal

9.1 Product description

Line	Description
1	Fittings as customs seal on the partition wall sliding door

9.2 Figure



Figure 8: Fittings – interior customs seal

9.3 Operation



NOTE

Risk of property damage due to improper customs seal.

- Observe the operating instructions on the respective sign.
- Only use one customs seal. Do not use a padlock!
- Observe the relevant customs seal regulations

Using fittings

- Note the information on the sign before use.



10 Locking system on partition wall sliding door

10.1 Product description

Line	Description
1	DHL security lock with partition wall sliding door monitor

The locking system is built into the partition wall sliding door.

10.2 Figure

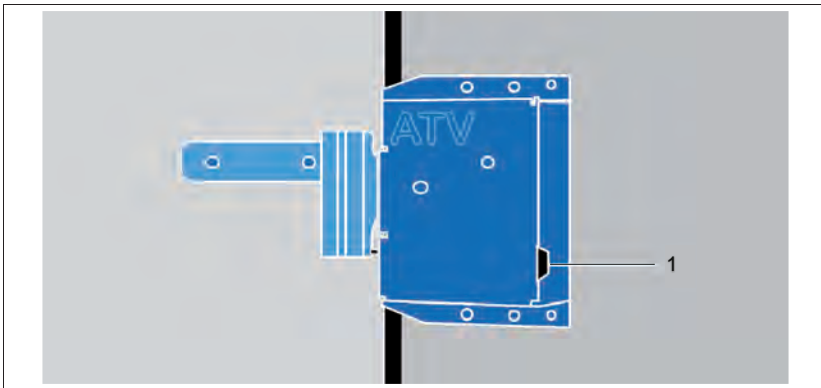

Figure 9: Locking system on partition wall sliding doors, ATV brand, closed state

1	Button on lock
---	----------------

10.3 Operation



CAUTION

Risk of personal injury due to crushing if partition wall sliding door not locked in place.

- ♦ Close the partition wall sliding door before driving and ensure it is locked in place.
- ♦ Keep fingers away from the latch and potential crushing points on the door whilst closing and opening.



NOTE Adjustment of the sliding partition door:

- ♦ When installing the ATV locking system on the factory-fitted partition sliding door (factory code D64), the partition sliding door **must be checked regularly and adjusted** if necessary.
- ♦ The partition sliding door must be adjusted in such a way that the **locking hook is positioned exactly flush** with the lock.



NOTE

The locking system has the following safety features:

- Once unlocked, the partition wall sliding door can only be opened for a limited time (e.g. 10 seconds).
- If when the engine is running the display (H Unit) shows the warning "Body door open", a signal sounds similar to the seatbelt alarm, the partition wall sliding door needs to be closed.

Opening the partition wall sliding door from driver's cab

1. Unlock the partition wall sliding door using one of the following methods:
 - With engine on: Turn off the engine.
 - If engine off: Turn the engine on, then off again.

The sliding door is unlocked for a specific period (e.g. 10 seconds). If the door is not opened during this time, it will lock again.

2. Slide the sliding door all the way to the right.

Closing the partition wall sliding door from the driver's cab

- Slide the sliding door to the left until it engages.

Opening the partition wall sliding door inside cargo area

1. Press the button on the lock.
The sliding door is unlocked for a specific period (e.g. 10 seconds).
2. Slide the sliding door all the way to the left.

Closing the partition wall sliding door from the cargo area

- Slide the sliding door to the right until it engages.

11 Hand truck

11.1 Product description

Line	Description
1	Hand truck

11.2 Figure



Figure 10: Hand truck

11.3 Operation



CAUTION

Risk of personal injury due to crushing when unfolding and folding the blade.

- ♦ Note the crushing points.
- ♦ Secure or remove the hand truck as instructed (chapter 7).



NOTE

Handle the hand truck properly.

- ♦ Do not overload! Note the maximum weight capacity 120 kg.

Using the hand truck

- Lower the blade before use.



12 Locking system on cargo doors

12.1 Product description

Line	Description
1	Electronic locking system and theft protection

The locking system is built into the partition wall sliding door. All doors can be opened from outside the cargo area using a Dalles key. Only one door can be open at a time.

12.2 Figure

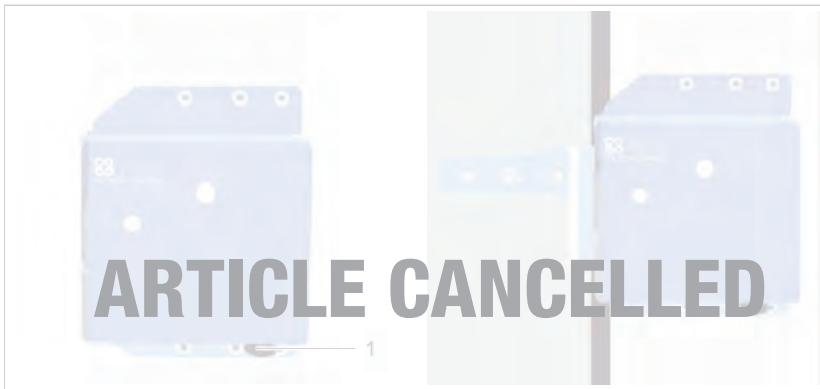

Figure 11: Locking system on cargo doors, view (left), closed (right)

1	Button on lock
---	----------------



Figure 12: Locking system on cargo doors, opening with Dalles key



12.3 Operation



CAUTION

Risk of personal injury due to crushing if partition wall sliding door not locked in place.

- Close the partition wall sliding door before driving and ensure it is locked in place.
- Keep your fingers off the lock and potential crushing points on the doors whilst opening and closing. Caution in the swing range.



NOTE

The locking system has the following safety features:

- Once unlocked, the doors can only be opened for a limited time (e.g. 10 seconds).
- Only one cargo door can be opened at a time.
- A warning will sound when opening more than one cargo door.

12.3.1 Partition wall sliding door

Open from driver's cab

1. Hold the release key up to the magnetic contact on the partition wall sliding door.
The sliding door is unlocked for a specific period (e.g. 10 seconds). If the door is not opened during this time, it will lock again.
2. Slide the sliding door all the way to the right.

Close from driver's cab

- Slide the partition wall sliding door to the left until it engages.

Open from inside cargo area

1. Prerequisite: The vehicle is closed properly.
2. Press the button on the lock.
The sliding door is unlocked for a specific period (e.g. 10 seconds).
3. Slide the sliding door all the way to the left.

Close from inside cargo area

- Slide the sliding door to the right until it engages.



12.3.2 Sliding side cargo door

Open from inside cargo area

1. Prerequisite: The vehicle is closed properly.
2. Use the factory opening mechanism.
3. Slide the sliding cargo door to the right until it engages.

Open from outside

1. Prerequisite: The vehicle is closed properly.
2. Hold the Dalles key up to the magnetic contact on the side of the vehicle. The sliding door is unlocked for a specific period (e.g. 10 seconds).
3. Slide the side sliding cargo door to the left until it engages.

Close

- Close the sliding cargo door with momentum.

12.3.3 Back door

Open from inside cargo area

1. Prerequisite: The vehicle is closed properly.
2. Use the factory opening mechanism.
3. Open the back door until it engages.

Open from outside

1. Prerequisite: The vehicle is closed properly.
2. Hold the Dalles key up to the magnetic contact at the back of the vehicle. The sliding door is unlocked for a specific period (e.g. 10 seconds).
3. Open the back door until it engages.

Close

- Close the back door with momentum.

ARTICLE CANCELLED



13 Locking system on cargo doors – ATV brand

13.1 Product description

Line	Description
1	Electronic locking system and theft protection, ATV brand

The locking system is built into the partition wall sliding door. The side sliding door of the cargo area and the back door can be opened with the vehicle's remote control. Only one door can be open at a time.

13.2 Figure

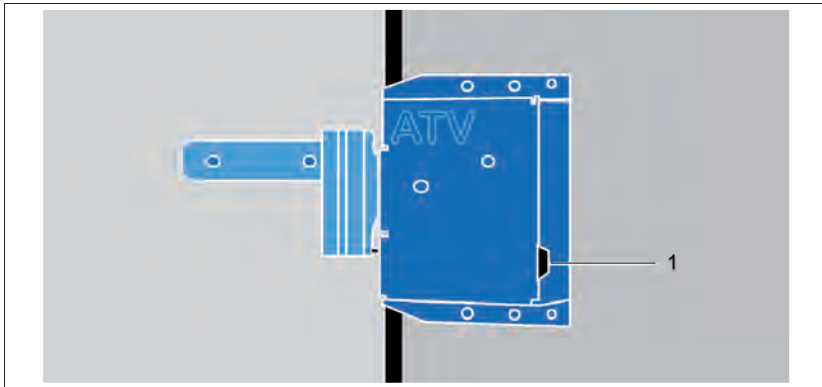

Figure 13: 1 Locking system on cargo doors ATV brand, closed

1	Button on lock
---	----------------

13.3 Operation



CAUTION

Risk of personal injury due to crushing if partition wall not engaged.

- ♦ Close the partition wall sliding door before driving and ensure it is locked in place.
- ♦ Keep your fingers off the lock and potential crushing points on the doors whilst opening and closing. Caution in the swing range.



NOTE

The locking system has the following safety features:

- Once unlocked, the doors can only be opened for a limited time (e.g. 10 seconds).
- Only one cargo door can be opened at a time.
- The "Cargo area" button on the remote control unlocks both the side sliding door and the back door, but only one door can be open at a time.
- A warning will sound when opening more than one cargo door.
- If when the engine is running the display (Hea Unit) show the warning "Body door open", a signal sounds similar to the seatbelt alarm, the partition wall sliding door needs to be closed.

13.3.1 Opening the partition wall sliding door from driver's cab

1. Prerequisite: The vehicle is closed properly.
2. Unlock the sliding door using one of the following methods:
 - With engine on: Turn off the engine.
 - If engine off: Turn the engine on, then off again.

The sliding door is unlocked for a specific period (e.g. 10 seconds). If the door is not opened during this time, it will lock again.

3. Slide the sliding door all the way to the right.

Close from driver's cab

- Slide the sliding door to the left until it engages.

Open from inside cargo area

1. Press the button on the lock.
The sliding door is unlocked for a specific period (e.g. 10 seconds).
2. Slide the sliding door all the way to the left.

Close from inside cargo area

- Slide the sliding door to the right until it engages.

13.3.2 Opening the sliding side cargo door from the cargo area

1. Prerequisite: The vehicle is closed properly.
2. Use the factory opening mechanism.
3. Slide the sliding cargo door to the right until it engages.



Open from outside

1. Prerequisite: The vehicle is closed properly.
2. Press the "Cargo area" button on the remote control.
The sliding door is unlocked for a specific period (e.g. 10 seconds).
3. Use the factory opening mechanism.
4. Slide the sliding cargo door to the left until it engages.

Close

- Close the sliding cargo door with momentum.

13.3.3 Back door

Open from inside cargo area

1. Prerequisite: The vehicle is closed properly.
2. Use the factory opening mechanism.
3. Open the back door until it engages.

Open from outside

1. Prerequisite: The vehicle is closed properly.
2. Press the "Cargo area" button on the remote control. Back door unlocked.
3. Use the factory opening mechanism.
4. Open the back door until it engages.

Close

- Close the back door with momentum.



NOTE Adjustment of the sliding partition door:

- ♦ When installing the ATV locking system on the factory-fitted partition sliding door (factory code D64), the partition sliding door **must be checked regularly and adjusted** if necessary.
- ♦ The partition sliding door must be adjusted in such a way that the **locking hook is positioned exactly flush** with the lock.





14 DPS holder – fixed partition wall

14.1 Product description

Line	Description
1	DPS holder on fixed partition wall of the base vehicle

14.2 Figure



Figure 14: DPS holder – fixed partition wall

14.3 Operation

Using the DPS holder

- If necessary, use the bracket.





15 DPS holder – partition wall with sliding door

15.1 Product description

Line	Description
1	DPS holder on partition wall with sliding door

15.2 Figure



Figure 15: DPS holder – partition wall with sliding door

15.3 Operation

Using the DPS holder

- If necessary, use the bracket.



16 Key tags

16.1 Product description

Line	Description
1	Inscribed key tags

16.2 Figure



Figure 16: Key tags

16.3 Operation

Using key tags

- Use key tags as necessary.

17 High-visibility vests

17.1 Product description

Line	Description
1	2 count high-visibility vests

17.2 Figure



Figure 17: High-visibility vests

17.3 Operation



CAUTION

Risk of personal injury and property damage due to mishandling.

- Observe the instructions for the high-visibility vests.
- Observe the country-specific regulations.

Wear high-visibility vests

- Keep the high-visibility vests within reach.



18 Telematics

18.1 Product description

Line	Description
1	Inmatix telematics system

18.2 Figure

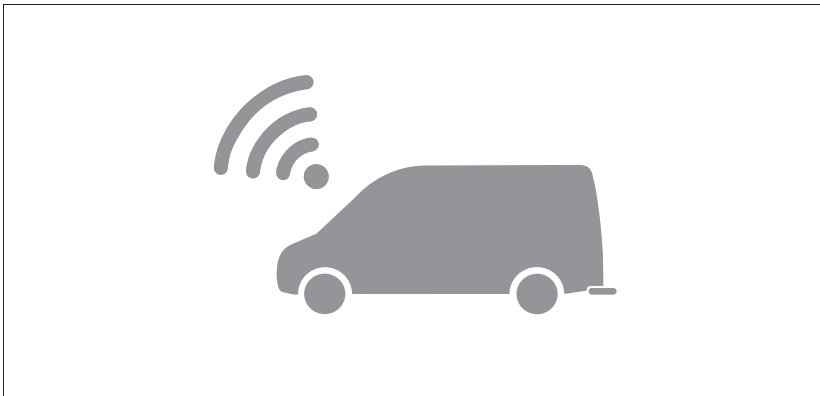

Figure 18: Telematics system

18.3 Operation

Using the telematics

- Use the telematics per the relevant rules. The procedures are determined by the operator.
- Observe the documents accompanying the telematics system.



19 Scanner / monitor mount

19.1 Product description

Line	Description
1	Charging cradle mount for scanner / monitor

19.2 Figure



Figure 19: Scanner / monitor mount

19.3 Operation



CAUTION

Risk of personal injury and property damage due to mishandling.

- ◆ Positioning of the monitor or scanner on the mount (right-hand-drive/left-hand-drive) is absolutely essential!
- ◆ Always place the monitor / scanner in the mount before driving to prevent it from falling down.
- ◆ Ensure the scanner/monitor are secure.
- ◆ If possible, keep the components out of the driver's field of view.

Using the scanner / monitor mount

1. Always position the monitor or scanner in the mount before driving.
2. Plug the supply cable into the cigarette lighter socket to charge.

20 Document pouch

20.1 Product description

Line	Description
1	DIN A4 document pouch on the partition wall or next to the driver's seat and press studs on the shelf

20.2 Figure



Figure 20: Document pouch

20.3 Operation



CAUTION

Risk of personal injury and property damage due to mishandling.

- For the driver's safety, store all documents in the document pouch or other storage areas in the vehicle. Do not leave anything out.



NOTE

Handle the document pouch properly.

- Do not overload! Note the maximum weight capacity 0.5 kg.

Using the document pouch

- Store documents in the document pouch before driving.
- Press studs to secure it are located behind the driver's seat and on the shelf in the cargo area.

21 Fittings – exterior customs seal

21.1 Product description

Line	Description
1	Exterior fittings as customs seal on the back door and on the side cargo sliding door

21.2 Figure

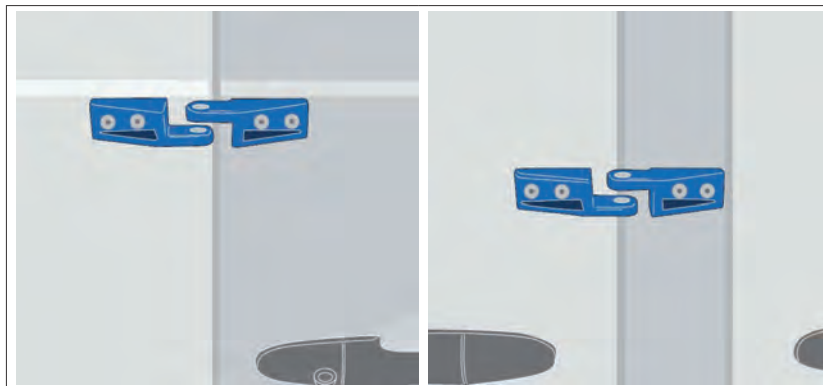

Figure 21: Fittings – Exterior customs seal, back door (left), sliding cargo door (right)

21.3 Operation



NOTE

Risk of property damage due to improper customs seal.

- ♦ Observe the operating instructions on the respective sign.
- ♦ Only use one customs seal. Do not use a padlock!
- ♦ Observe the relevant regulations.

Using fittings

- Note the rules and operating instructions on the respective sign.



22 Fittings – for exterior padlock

22.1 Product description

Line	Description
1	Exterior fittings for the padlock on the back door and on the side cargo sliding door

22.2 Figure

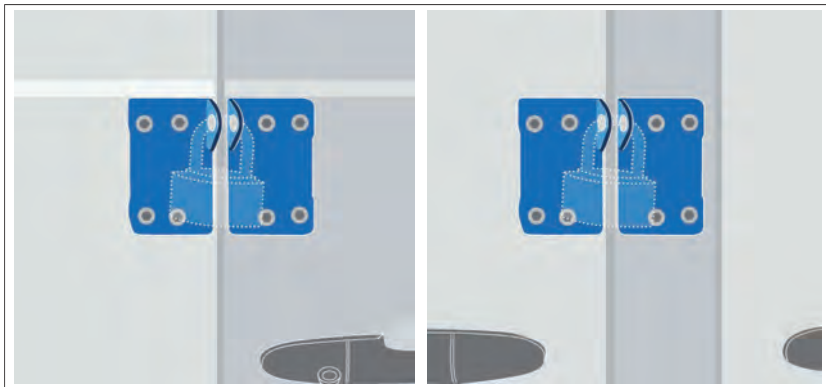

Figure 22: Fittings for padlock, back door (left), sliding cargo door (right)

22.3 Operation



NOTE

Risk of property damage due to failure to properly secure the lock.

- ♦ Note the operating instructions on the respective sign.
- ♦ Only use these fittings together with the Spier padlock (chapter 23)!
- ♦ Do not use as a customs seal.

Using fittings

- Note the rules and operating instructions on the respective sign.



23 Padlock

23.1 Product description

Line	Description
1	Padlock with rubber coating for the fitting on the back door and on the side sliding cargo door

23.2 Figure

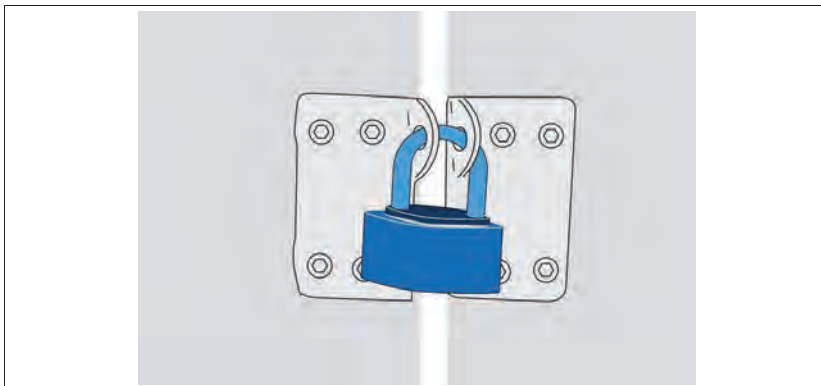

Figure 23: Padlock

23.3 Operation



NOTE

Risk of property damage due to failure to properly secure the lock.

- Note the operating instructions on the respective sign.
- Only use the Spier padlock on the padlock fittings (chapter 22)!

Using the padlock

- Note the rules and operating instructions on the respective sign.

24 Rear step / Side step

24.1 Product description

Line	Description
1	Spring-loaded rear step
2	Side step, inflexible

24.2 Figure



Figure 24: Rear step

Side step

24.3 Operation



CAUTION

Risk of personal injury due to operating error.

- When using the rear step, hold onto the handle on the right back door (chapter 6) or a suitable handle on the
- Do not use the rear step whilst

Using the rear step

- Secure yourself when entering/exiting by holding onto the rear handle.

25 Partition wall with sliding door

25.1 Product description

Line	Description
1	Partition wall with sliding door

25.2 Figure

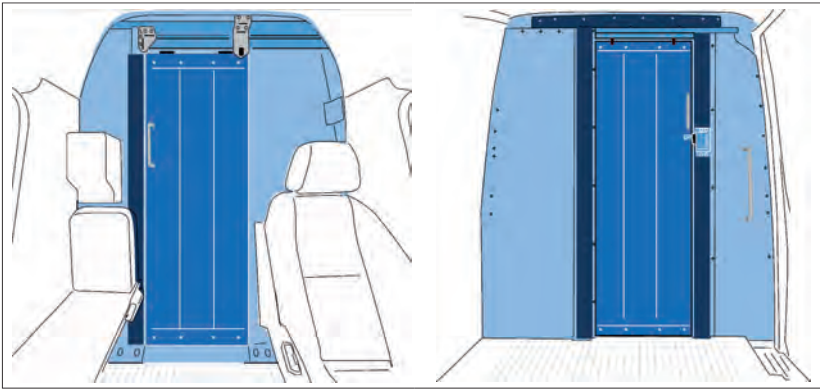
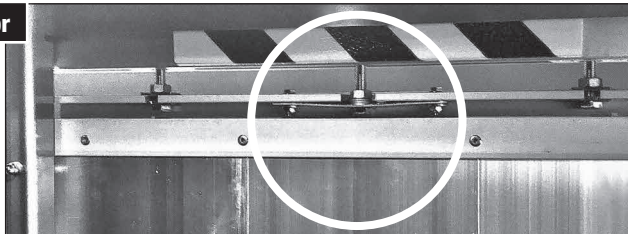



Figure 25 Partition wall with sliding door, view from driver's cab (left), view from cargo area (right)

Adjust sliding door

ATTENTION! Please adjust the sliding door after 4 weeks! Adjust the middle screw on the upper edge of the door depending on the desired preload.



25.3 Warning and information sign

No.	Warning / information sign	Consequences for users
1		<p>Caution! Risk of personal injury due to overhead obstacle.</p> <ul style="list-style-type: none"> ♦ Note the clearance when using the partition door. ♦ Line: Top door frame



25.4 Operation



CAUTION

Risk of personal injury due to crushing if partition wall sliding door not locked in place.

- Close the partition wall sliding door before driving and ensure it is locked in place.
- Observe the safety and operating instructions of the respective locking system.
- Keep fingers away from the latch and potential crushing points on the door whilst closing and opening.

Opening the partition wall sliding door from driver's cab

- Slide the sliding door all the way to the right.

Closing the partition wall sliding door from the driver's cab

- Slide the sliding door to the left until it engages.

Opening the partition wall sliding door inside cargo area

- Slide the sliding door all the way to the left.

Closing the partition wall sliding door from the cargo area

- Slide the sliding door to the right until it engages.



26 Storage compartment for charging cable bag

26.1 Product description

Pos	Description
1	Storage compartment for charging cable bag (BEV)

26.2 Figure

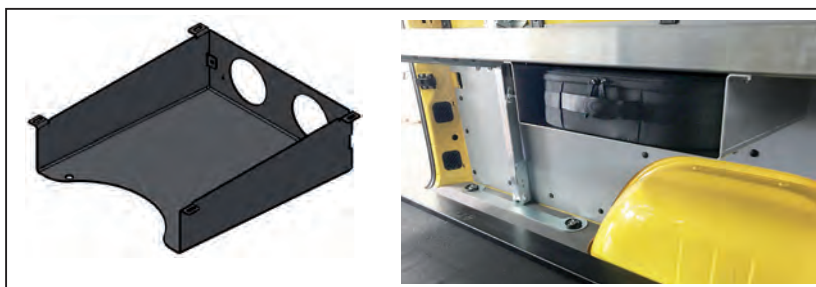

Figure 26: Sketch

Placement in the vehicle

26.3 Warning



CAUTION

Personel injury an material damage are possible when moving in the cargo area.

- ♦ Only use the holder for the charging cable bag.

26.4 Operation

Charging cable bag in the holder:

- ♦ Insert the charging cable bag into the holder under the shelf.
Secure it with the snap hook (if available) through the hole in the sheet metal.

Remove the charging cable bag fromthe holder:

- ♦ Unlocking the snap hook (if available).
Pull the charging cable bag out of the holder towards the centre of the vehicle.



spier®

FAHRZEUGWERK



SPIER GmbH & Co. Fahrzeugwerk KG
Industriepark Bergheim
Schorlemerstraße 1
32839 Steinheim
Germany

Tel.: +49 5233 945-0
Web: www.spier.de
E-Mail: info@spier.de

spier®
FAHRZEUGWERK

ATV
FAHRZEUGECHNIK

| The companies of the SPIER Group

Copyright © 2025 - SPIER GmbH & Co. Fahrzeugwerk KG
All rights reserved. All contents of these operating instructions, particularly texts, photos and graphics, are copyrighted. Copyright SPIER GmbH.
Reproduction, distribution or transmission of any part of these operating instructions in any way or with any means, including photocopies, recordings or other electronic or mechanical methods prohibited.

